

ZZZ 199

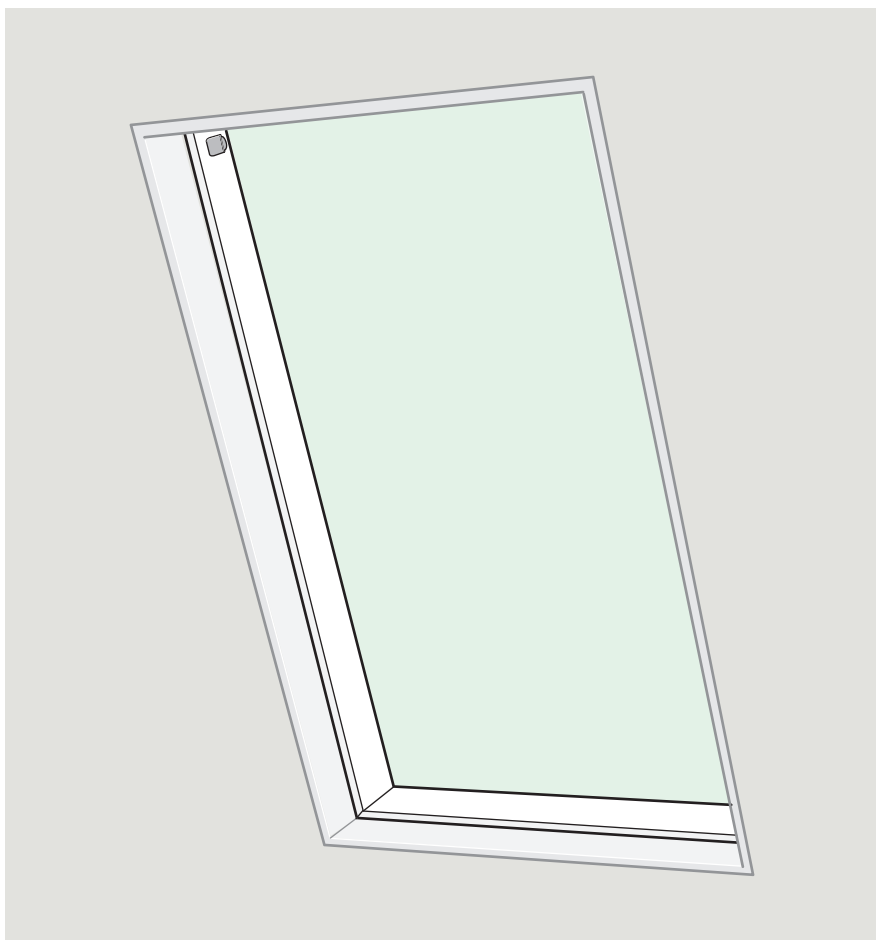

ENGLISH: FCM Accessory Tray Installation Instructions

ESPAÑOL: Instrucciones de instalación de la bandeja de FCM

FRANÇAIS : Instructions d'installation du plateau d'accessoires pour FCM



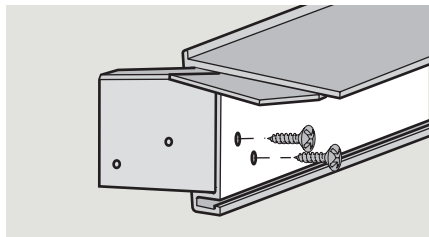
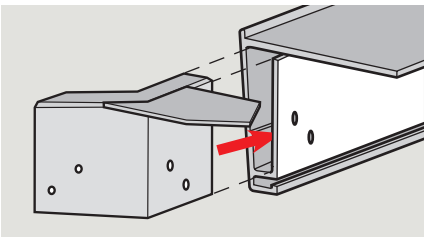
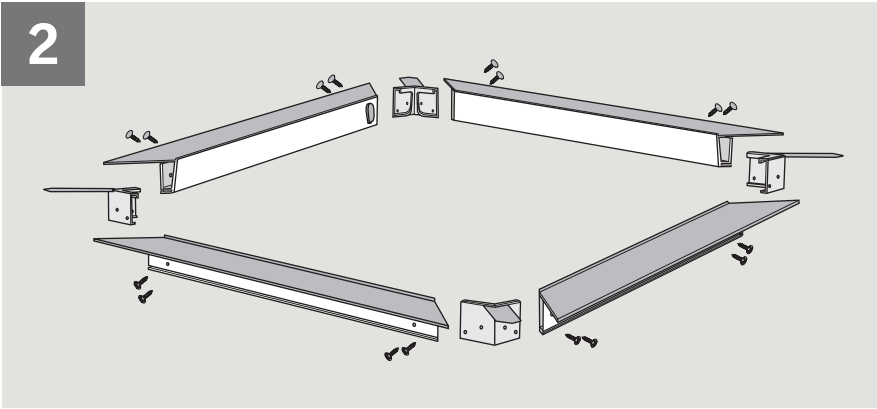
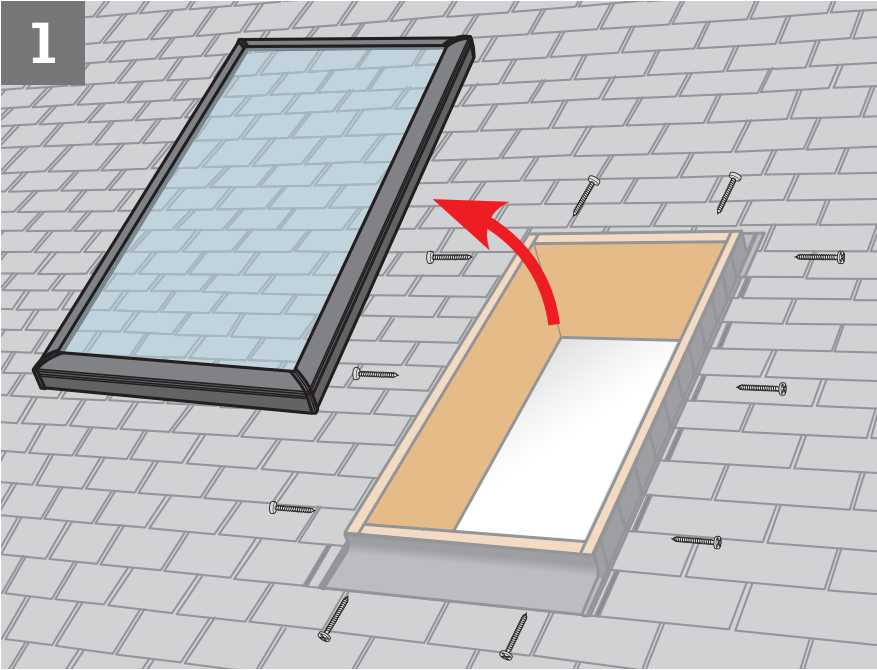

3

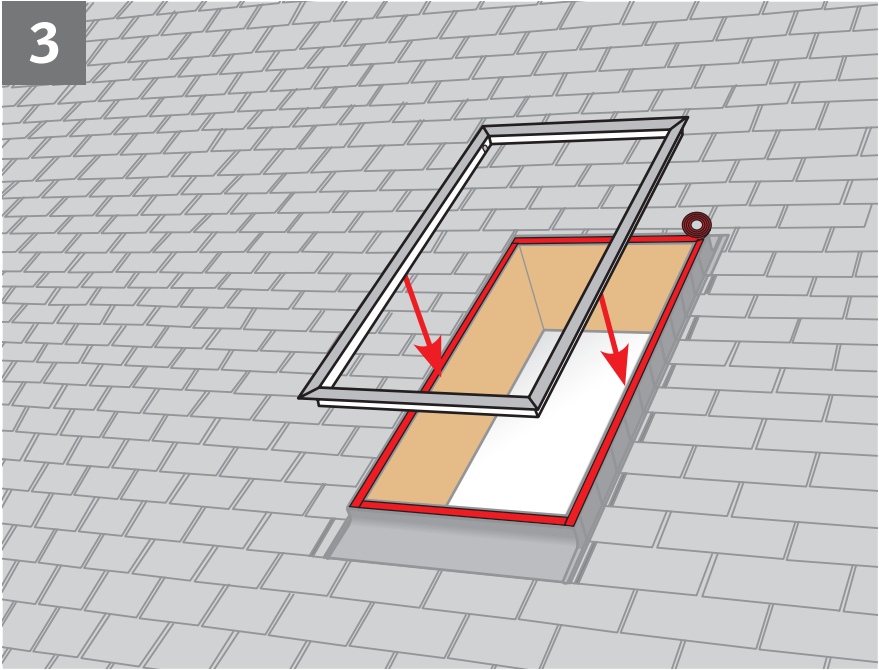

4

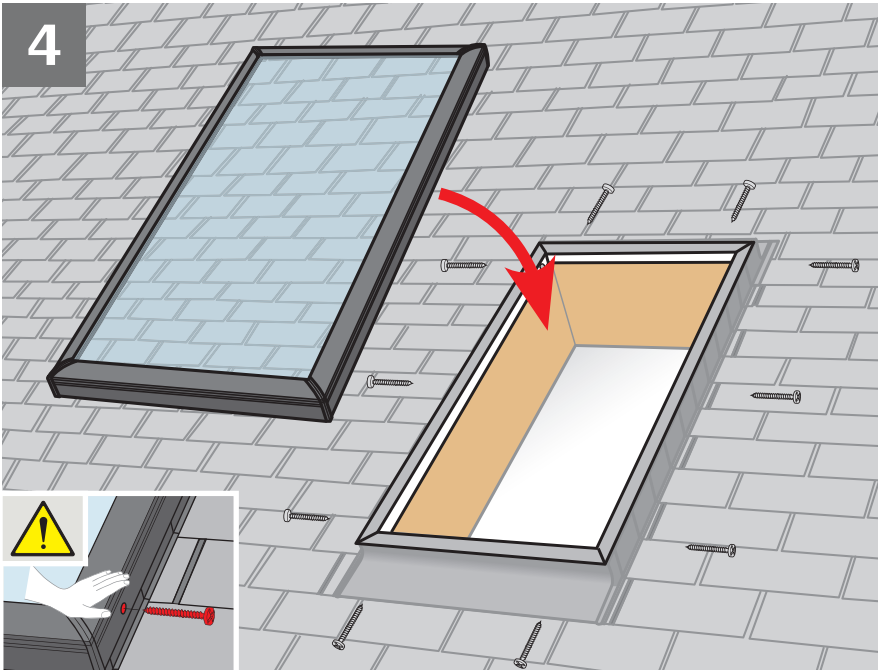

The logo consists of the word "VELUX" in a bold, white, sans-serif font, with a registered trademark symbol (®) to the upper right of the "X". The text is centered within a solid red rectangular background.

USA: VELUX America Inc.
1-800-88-VELUX

CDN: VELUX Canada Inc.
1 800 88-VELUX (888-3589)

AUS: VELUX Australia Pty. Ltd
(02) 9550 3288

NZ: VELUX New Zealand Ltd.
09-6344 126

www.velux.com